



DT CRAWLER 15



15,00 m



- 2,00 m

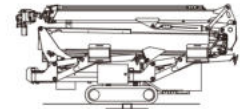

TON

1,55 T

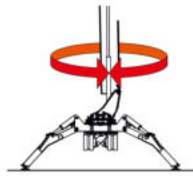

720°

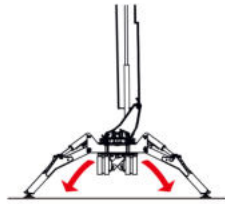

AUTO

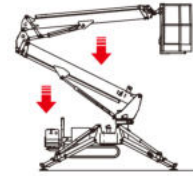

AUTO

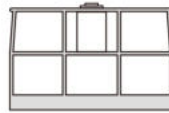

200 KG



ELECTRONIC



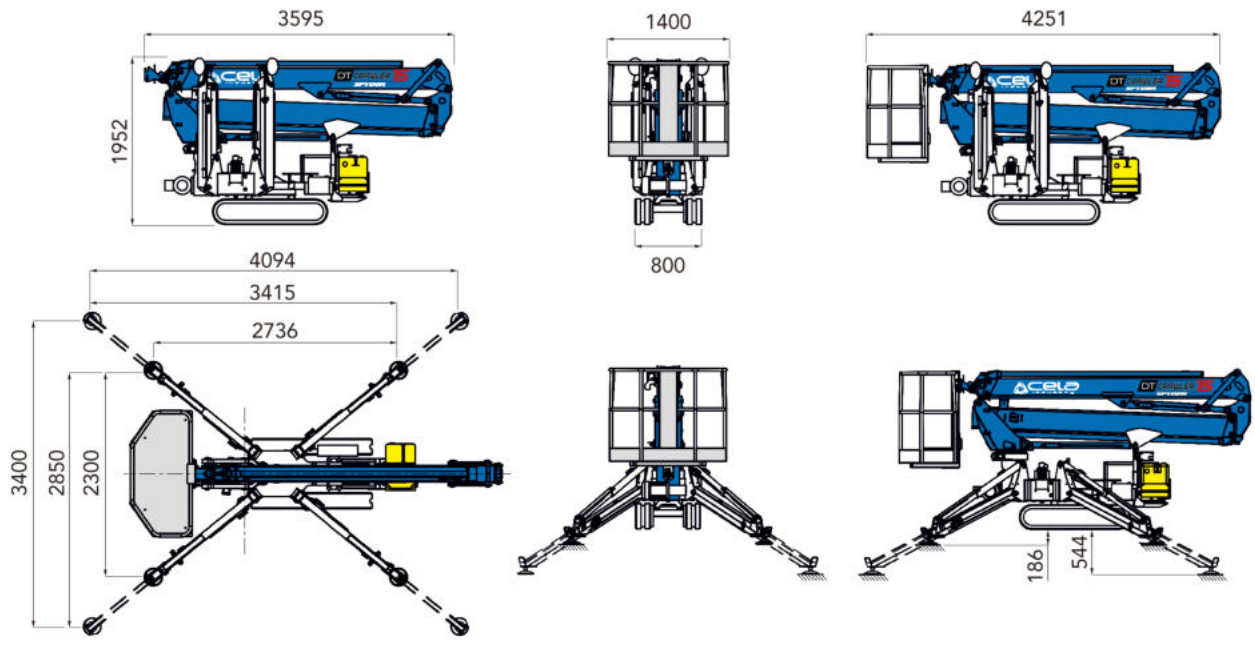
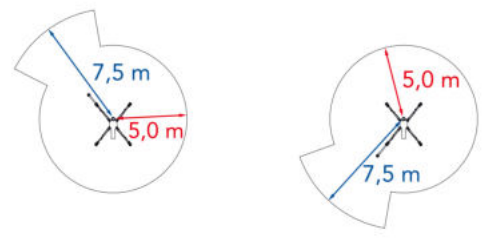
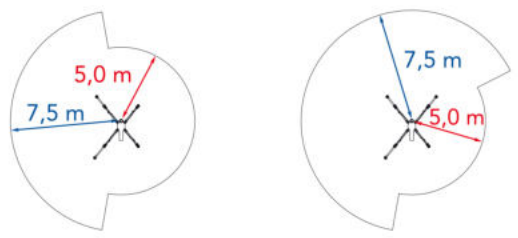
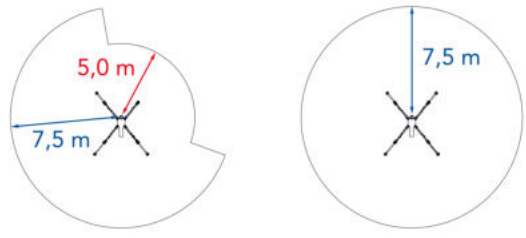
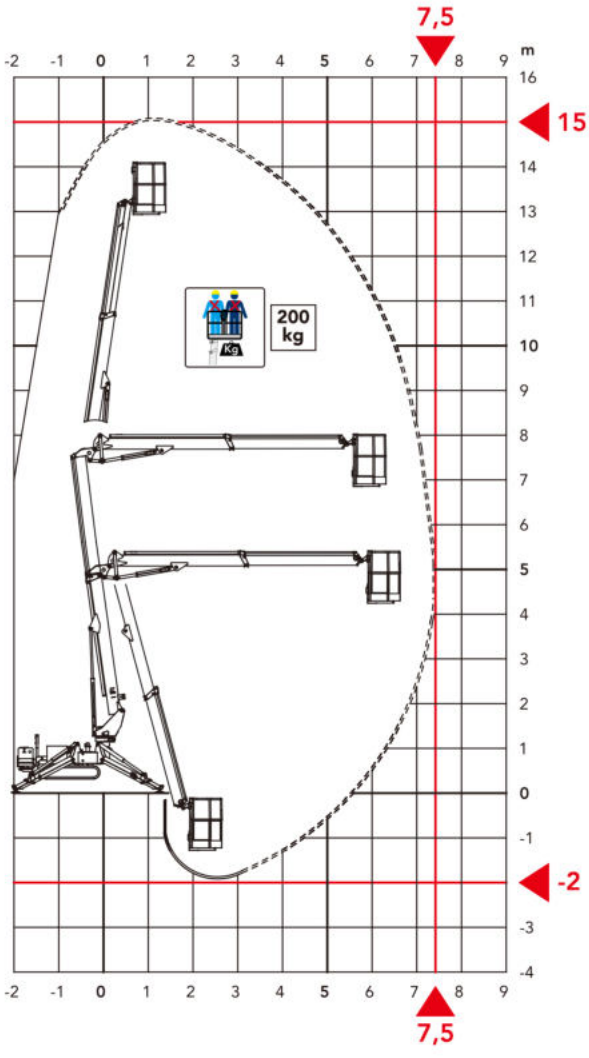

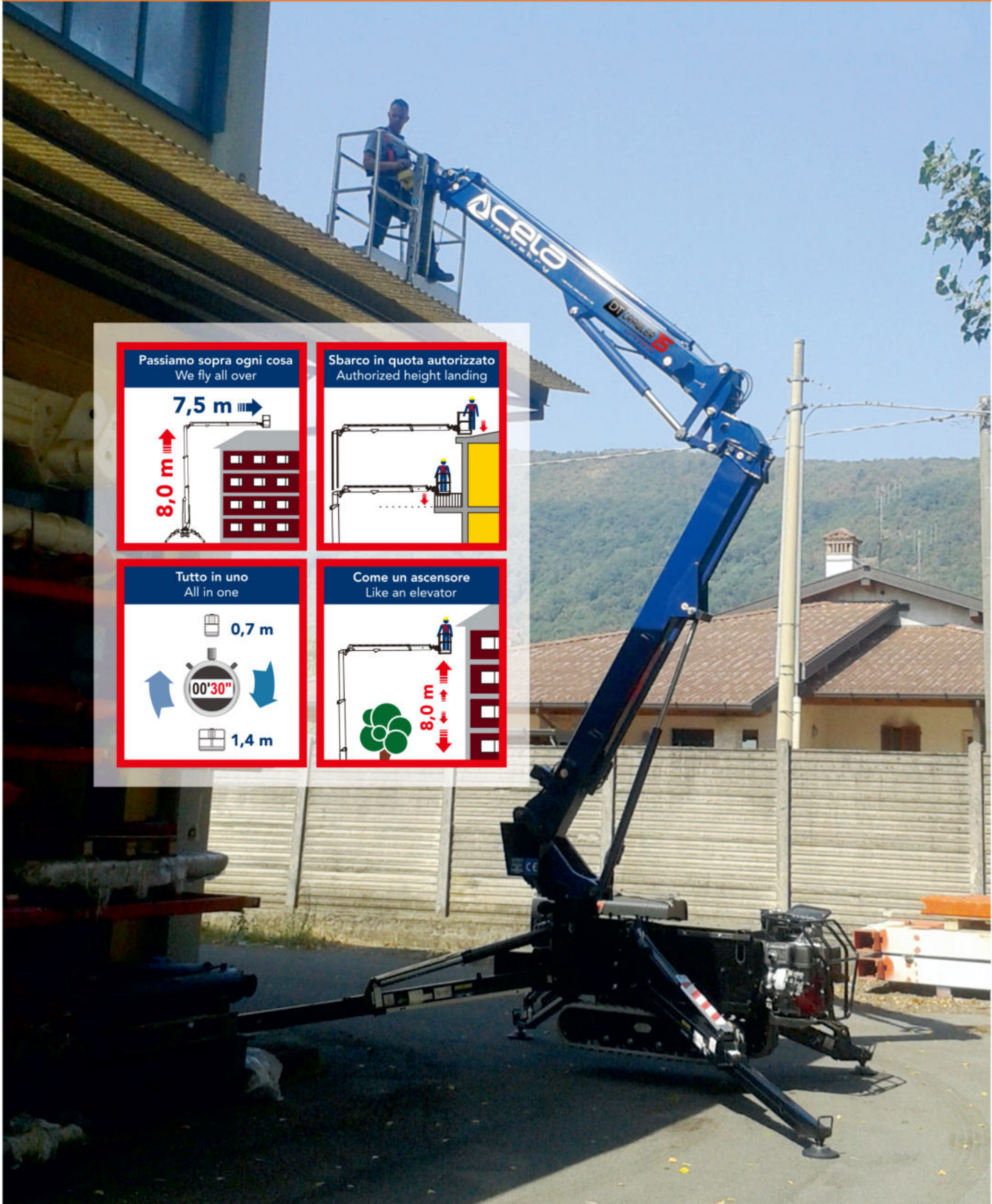

<p>Passiamo sopra ogni cosa We fly all over</p> <p>7,5 m →</p> <p>8,0 m ↑</p>	<p>Sbarco in quota autorizzato Authorized height landing</p>
<p>Tutto in uno All in one</p> <p>0,7 m</p> <p>00'30"</p> <p>1,4 m</p>	<p>Come un ascensore Like an elevator</p> <p>8,0 m</p>